

Selection Guide

| Part No. | Dice | Lens Type | Iv (mcd) [2] @ 20mA | | Viewing Angle [1] |
|--------------------|---------------------|-------------|------------------------|-------|----------------------|
| | | | Min. | Typ. | 2θ1/2 |
| L-154A4SUREQBFZGEC | Hyper Red (AlGaInP) | Water Clear | 650 | 1300 | 50° |
| | | | *200 | *400 | |
| | Blue (InGaN) | | 400 | 900 | |
| | | | *400 | *900 | |
| | Green (InGaN) | | 2200 | 3600 | |
| | | | *2200 | *3600 | |

Notes:

1. θ1/2 is the angle from optical centerline where the luminous intensity is 1/2 of the optical peak value.
 2. Luminous intensity/ luminous Flux: +/-15%.
- *Luminous intensity value is traceable to the CIE127-2007 compliant national standards.

Electrical / Optical Characteristics at TA=25°C

| Symbol | Parameter | Device | Typ. | Max. | Units | Test Conditions |
|--------------------|--------------------------|----------------------------|-------------------|----------------|-------|---------------------------|
| λ _{peak} | Peak Wavelength | Hyper Red Blue Green | 645 460 520 | | nm | I _F =20mA |
| λ _D [1] | Dominant Wavelength | Hyper Red Blue Green | 630 465 525 | | nm | I _F =20mA |
| Δλ _{1/2} | Spectral Line Half-width | Hyper Red Blue Green | 25 25 35 | | nm | I _F =20mA |
| C | Capacitance | Hyper Red Blue Green | 45 100 100 | | pF | V _F =0V;f=1MHz |
| V _F [2] | Forward Voltage | Hyper Red Blue Green | 1.9 3.3 3.2 | 2.5 4 4 | V | I _F =20mA |
| I _R | Reverse Current | Hyper Red Blue Green | | 10 50 50 | uA | V _R =5V |

Notes:

1. Wavelength: +/-1nm.
2. Forward Voltage: +/-0.1V.
3. Wavelength value is traceable to the CIE127-2007 compliant national standards.

Absolute Maximum Ratings at TA=25°C

| Parameter | Hyper Red | Blue | Green | Units |
|-------------------------------|---------------------|------|-------|-------|
| Power dissipation | 75 | 120 | 120 | mW |
| DC Forward Current | 30 | 30 | 30 | mA |
| Peak Forward Current [1] | 200 | 150 | 100 | mA |
| Reverse Voltage | 5 | | | V |
| Operating/Storage Temperature | -40°C To +85°C | | | |
| Lead Solder Temperature [2] | 260°C For 3 Seconds | | | |
| Lead Solder Temperature [3] | 260°C For 5 Seconds | | | |

Notes:

1. 1/10 Duty Cycle, 0.1ms Pulse Width.
2. 2mm below package base.
3. 5mm below package base.

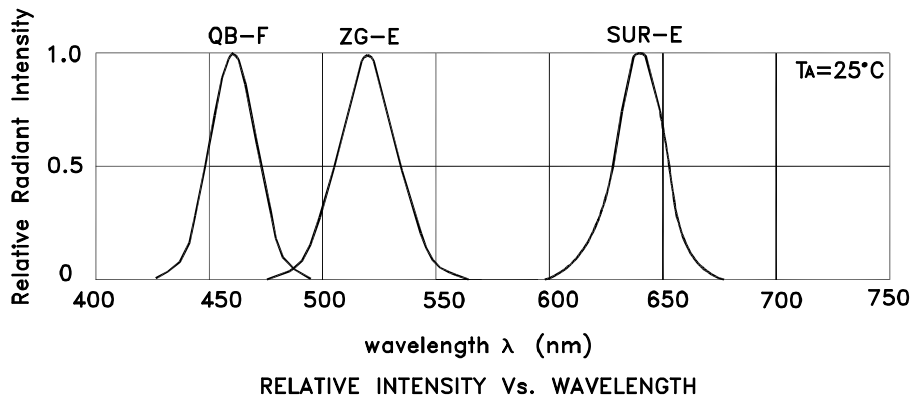

L-154A4SUREQBFZGEC Hyper Red

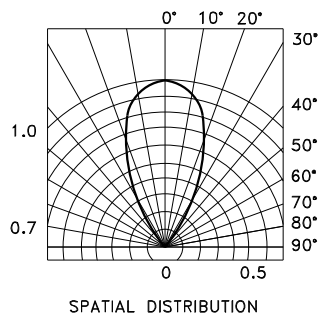
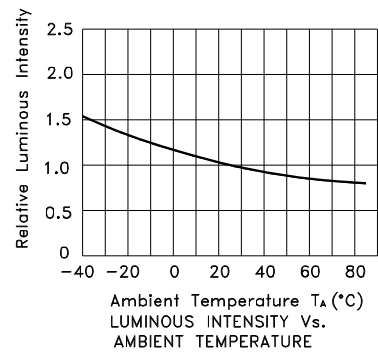
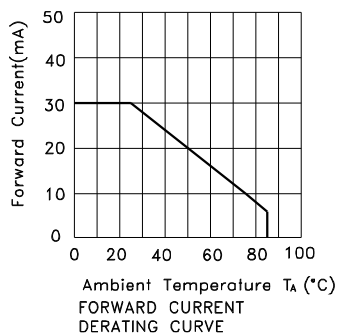
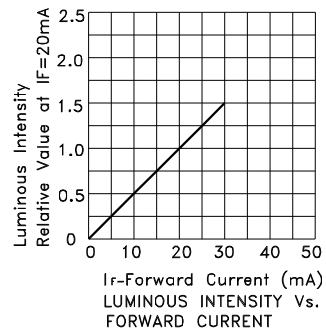
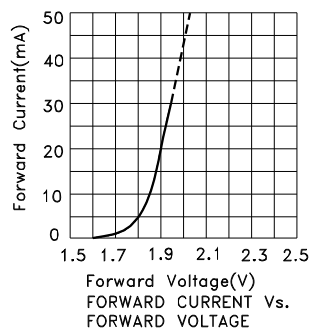

Kingbright

Blue

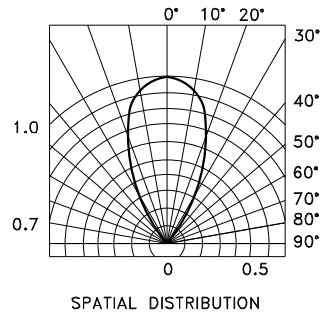
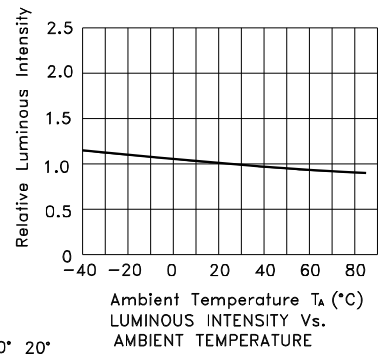
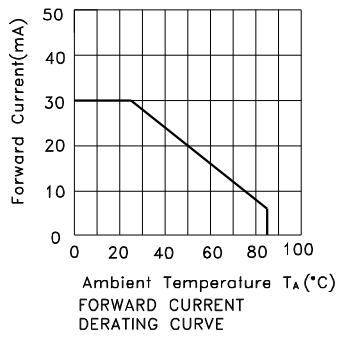
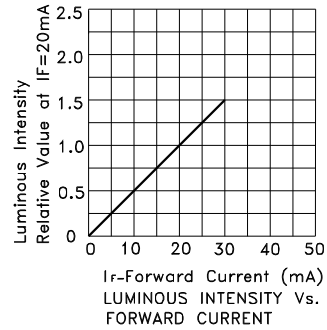
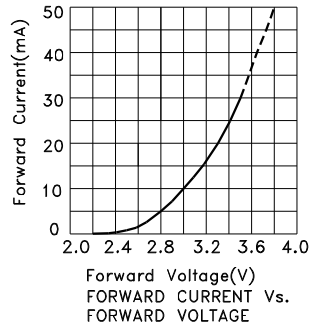

Green

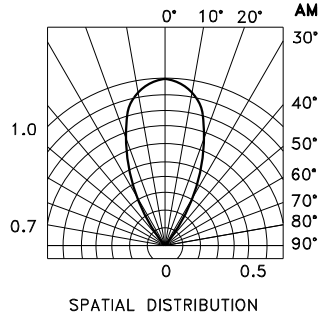
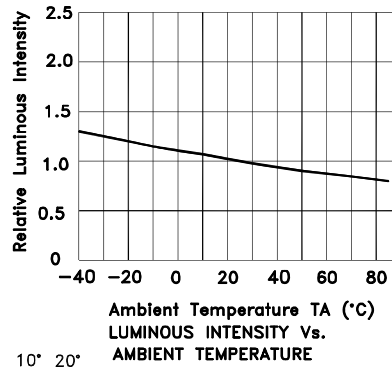
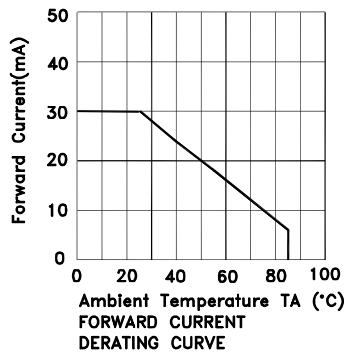
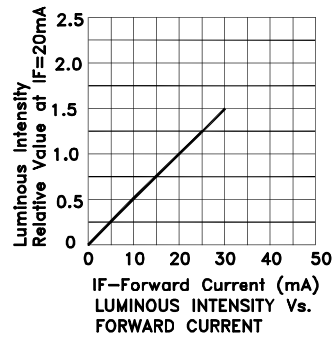
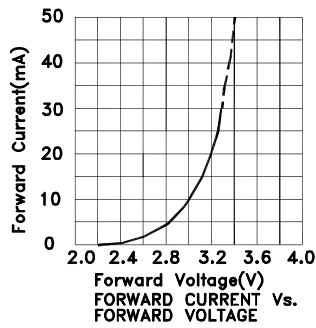

PACKING & LABEL SPECIFICATIONS

L-154A4SUREQBFZGEC

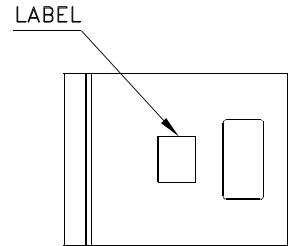
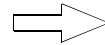
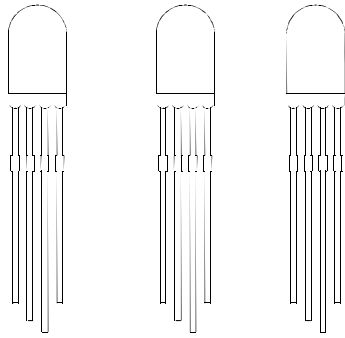

500PCS / BAG



20K / 9# BOX

OUTSIDE LABEL

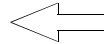

OUTSIDE LABEL

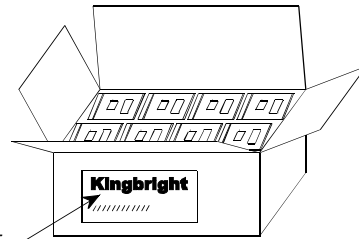

10K / 5# BOX

| | |
|--|--|
| <h1>Kingbright</h1> | |
| P/NO: L-154A4xxx | |
| QTY: 500 pcs | Q.C. Q C XX XX XXXX PASSED |
| S/N: XXXX | |
| CODE: XXX | |
| LOT NO: | |
|  xxxxxxxxxxxxxxxxxxxxxxxx | |
| RoHS Compliant | |

PRECAUTIONS

1. The lead pitch of the LED must match the pitch of the mounting holes on the PCB during component placement. Lead-forming may be required to insure the lead pitch matches the hole pitch. Refer to the figure below for proper lead forming procedures. (Fig. 1)

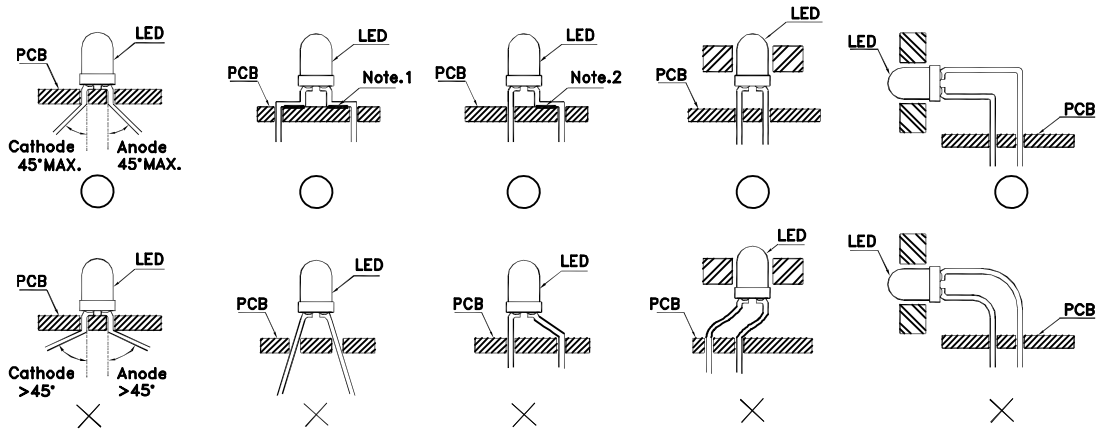

Fig.1

”O” Correct mounting method ”X” Incorrect mounting method

2. When soldering wire to the LED, use individual heat-shrink tubing to insulate the exposed leads to prevent accidental contact short-circuit. (Fig.2)
3. Use stand-offs (Fig.3) or spacers (Fig.4) to securely position the LED above the PCB.

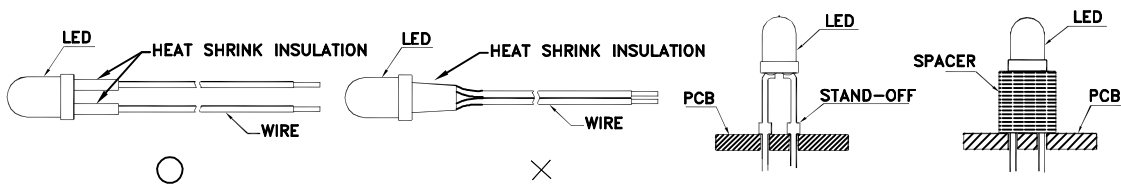

Fig. 2

Fig. 3

Fig. 4

4. Maintain a minimum of 2mm clearance between the base of the LED lens and the first lead bend. (Fig. 5 and 6)
5. During lead forming, use tools or jigs to hold the leads securely so that the bending force will not be transmitted to the LED lens and its internal structures. Do not perform lead forming once the component has been mounted onto the PCB. (Fig. 7)

6. Do not bend the leads more than twice. (Fig. 8)

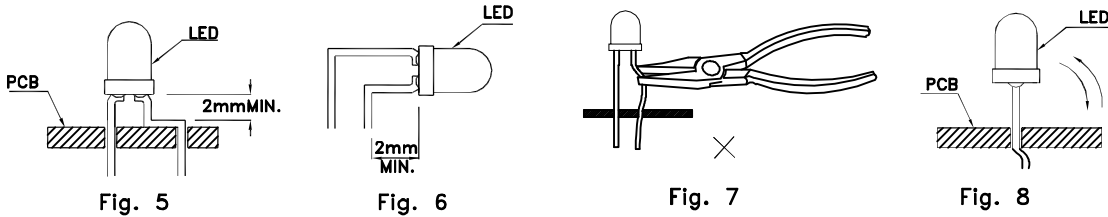

7. During soldering, component covers and holders should leave clearance to avoid placing damaging stress on the LED during soldering.

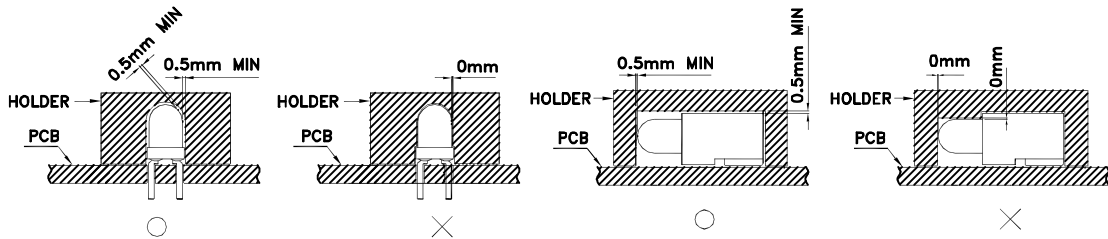

8. The tip of the soldering iron should never touch the lens epoxy.

9. Through-hole LEDs are incompatible with reflow soldering.

10. If the LED will undergo multiple soldering passes or face other processes where the part may be subjected to intense heat, please check with Kingbright for compatibility.

11. Recommended Wave Soldering Profiles:

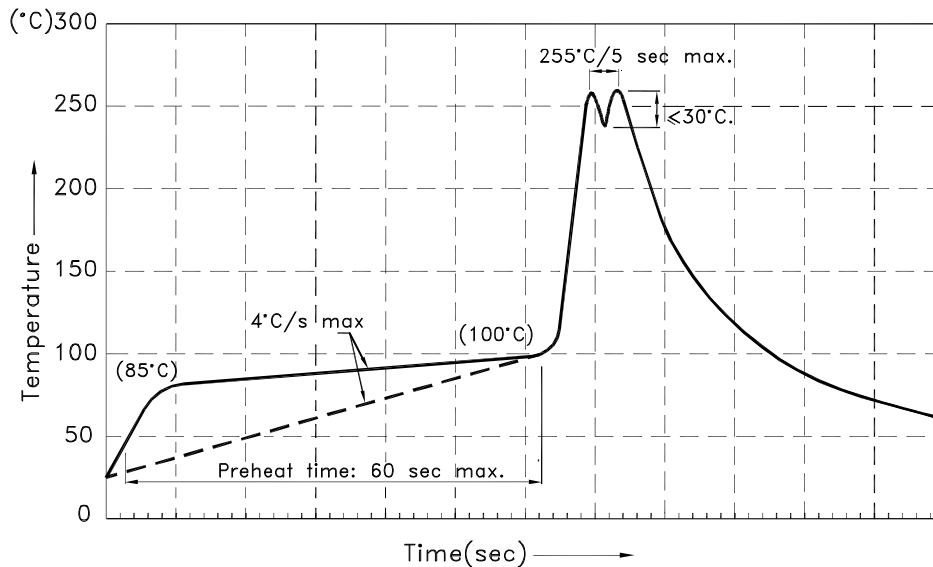

Notes:

1. Recommend pre-heat temperature of 105°C or less (as measured with a thermocouple attached to the LED pins) prior to immersion in the solder wave with a maximum solder bath temperature of 260°C
2. Peak wave soldering temperature between 245°C ~ 255°C for 3 sec (5 sec max).
3. Do not apply stress to the epoxy resin while the temperature is above 85°C.
4. Fixtures should not incur stress on the component when mounting and during soldering process.
5. SAC 305 solder alloy is recommended.
6. No more than one wave soldering pass.

Detailed application notes are listed on our website.

http://www.kingbright.com/application_notes